

20.68.1004.00

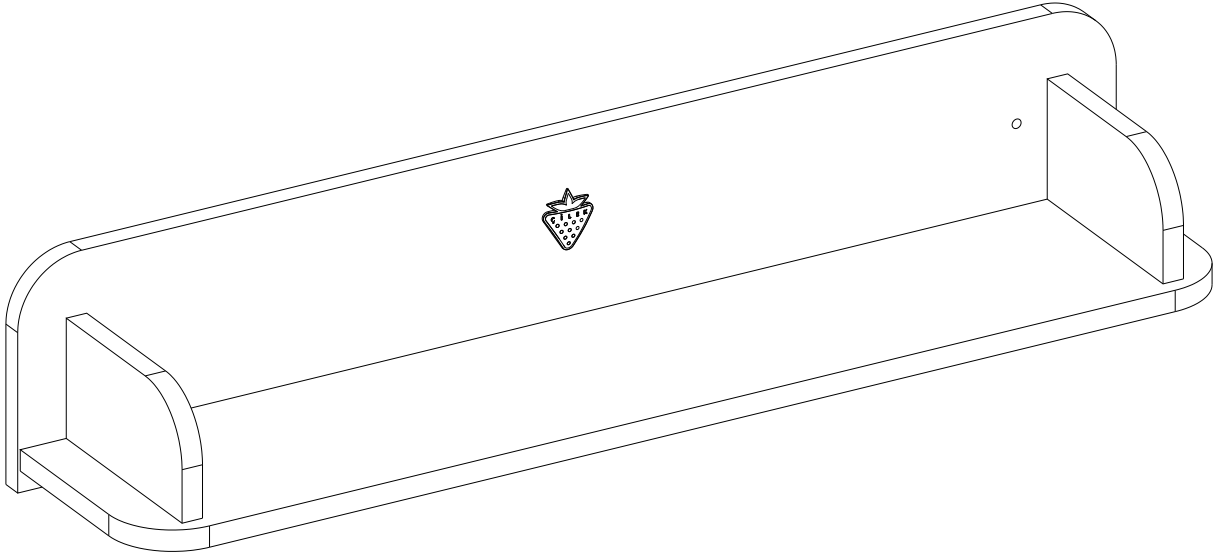

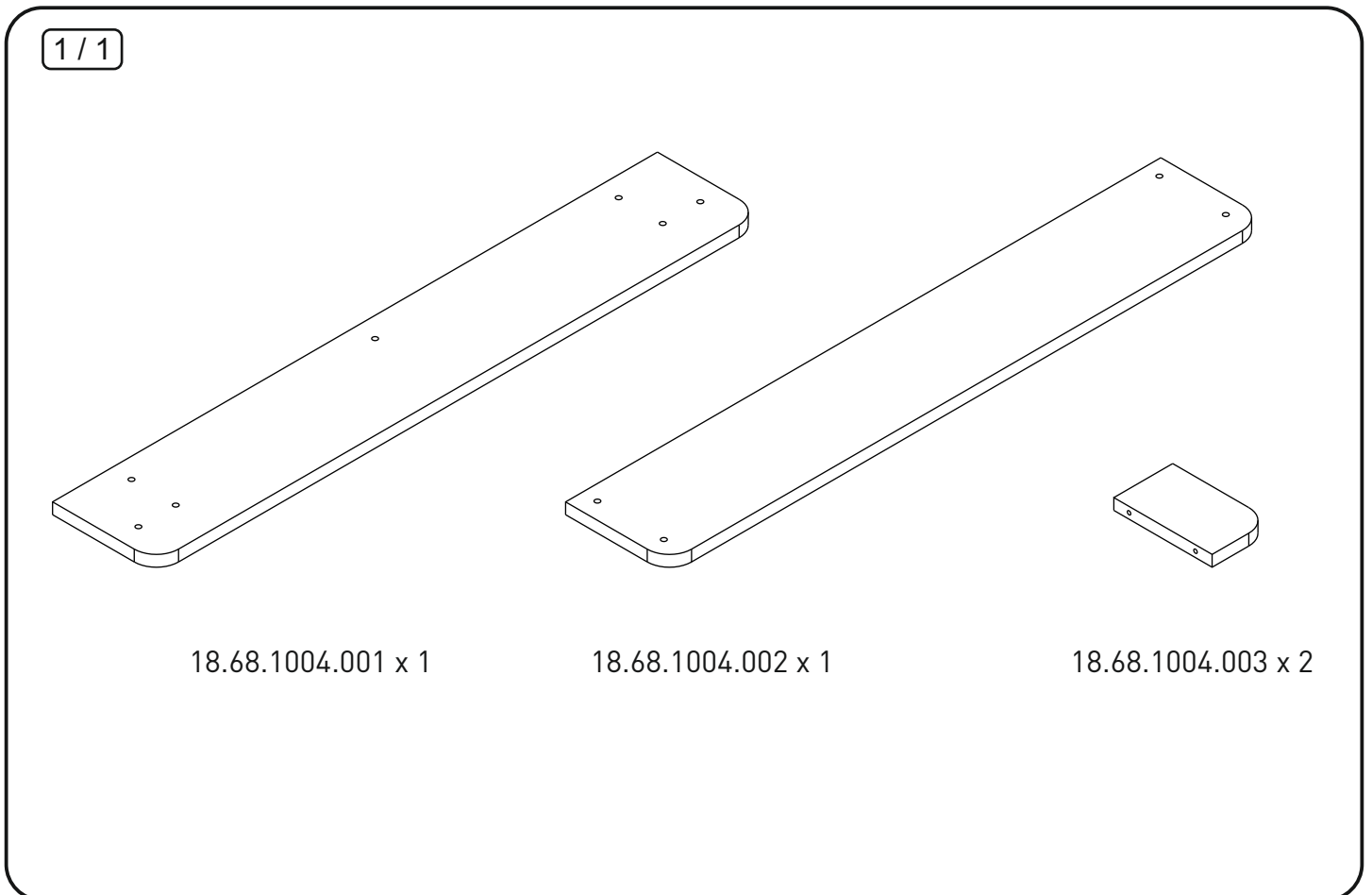

1

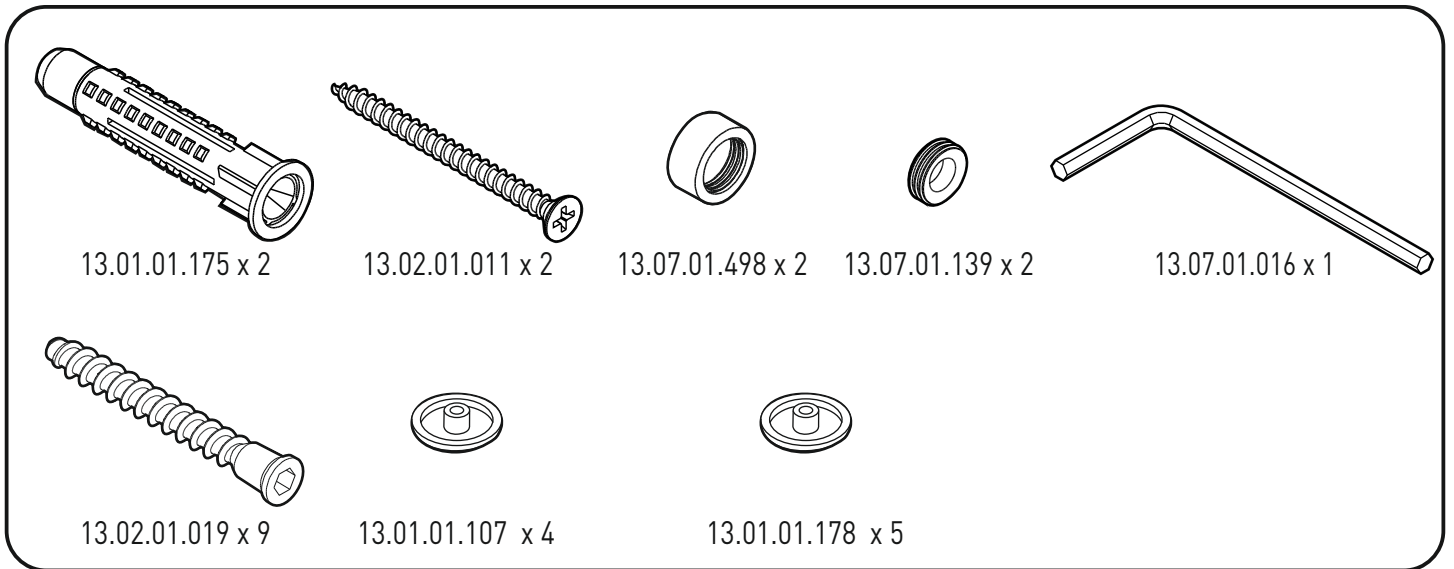
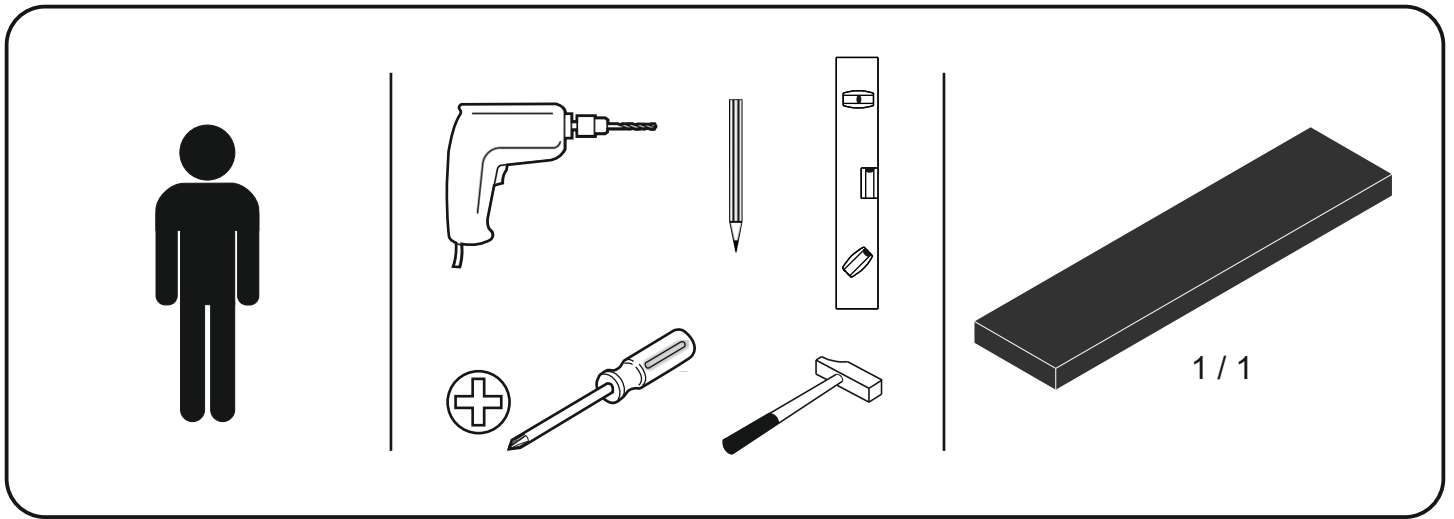
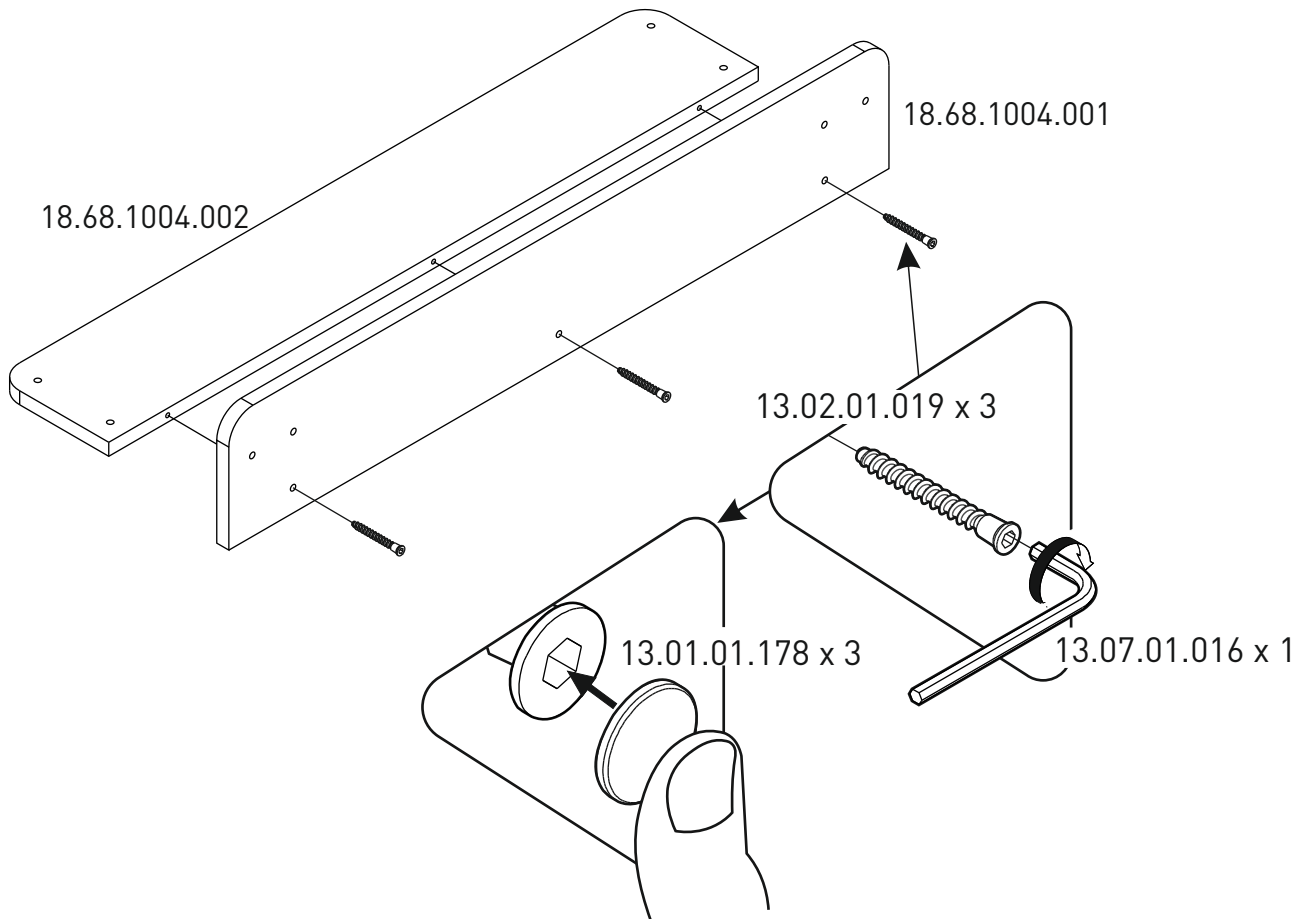

2

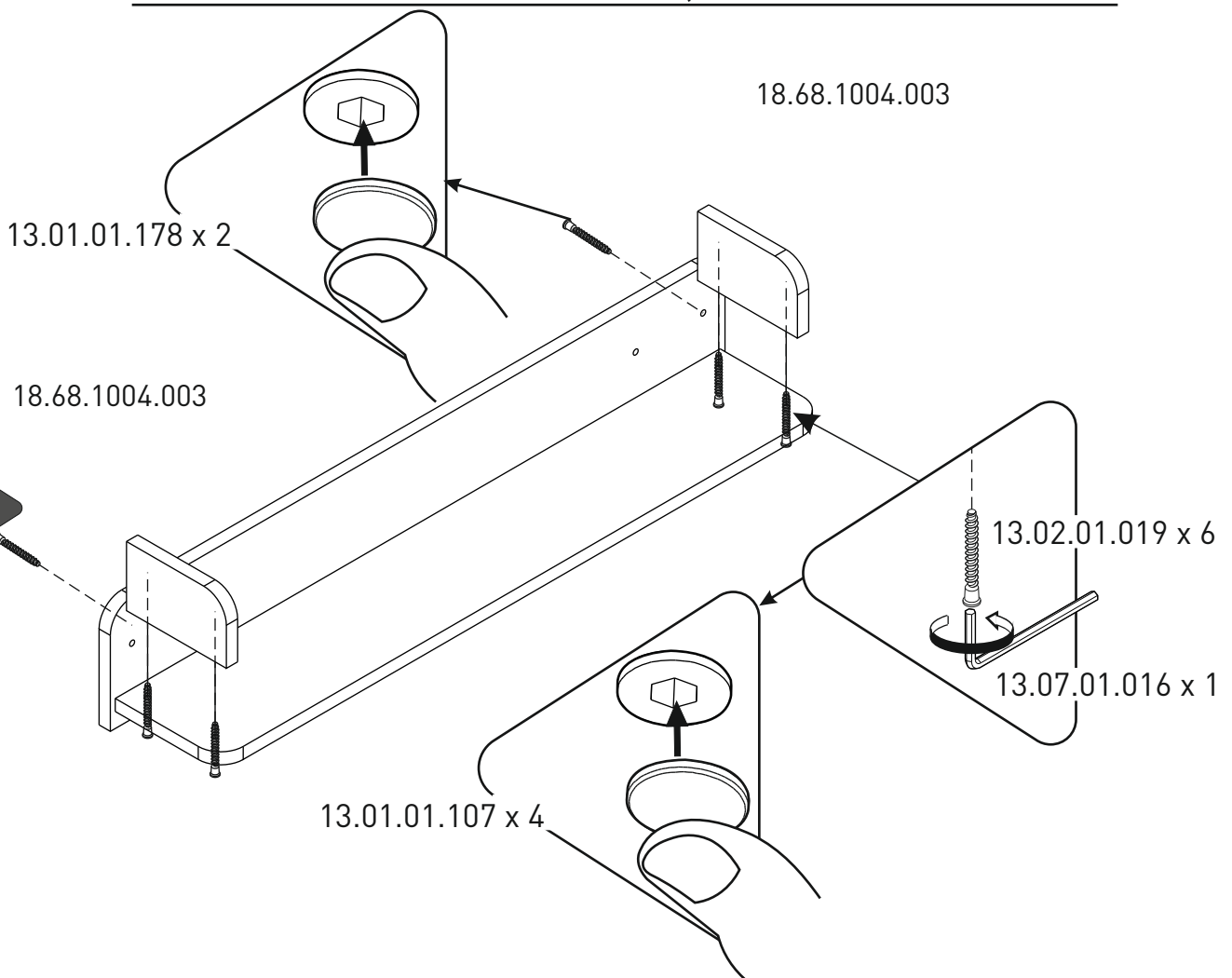

3

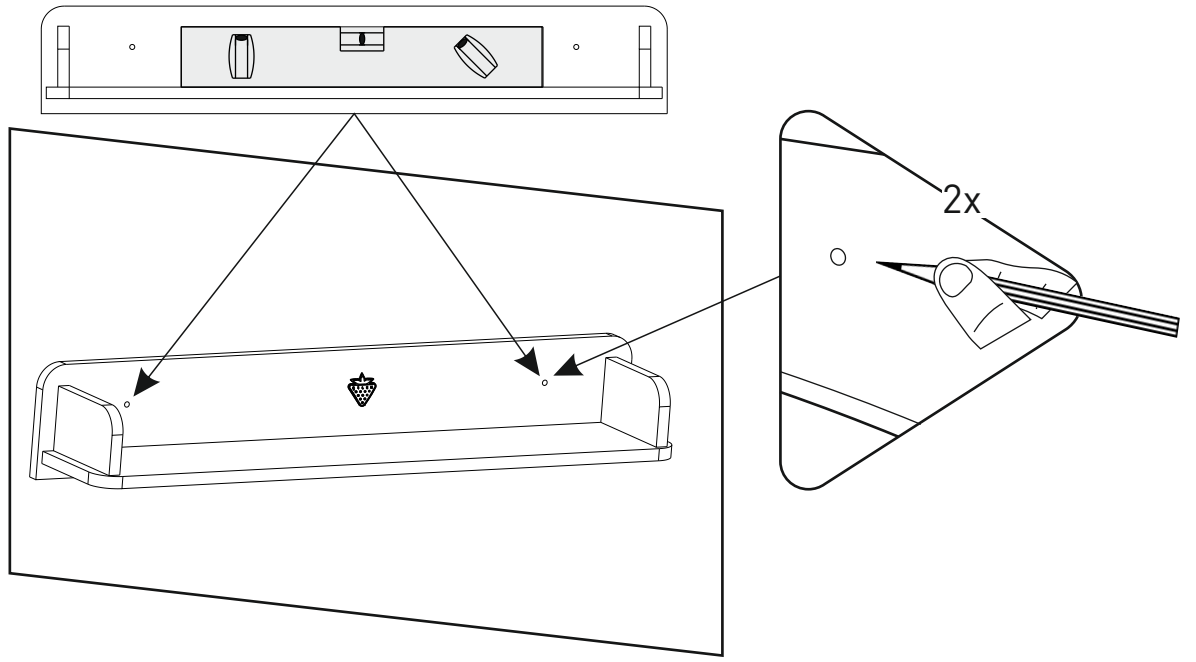

4

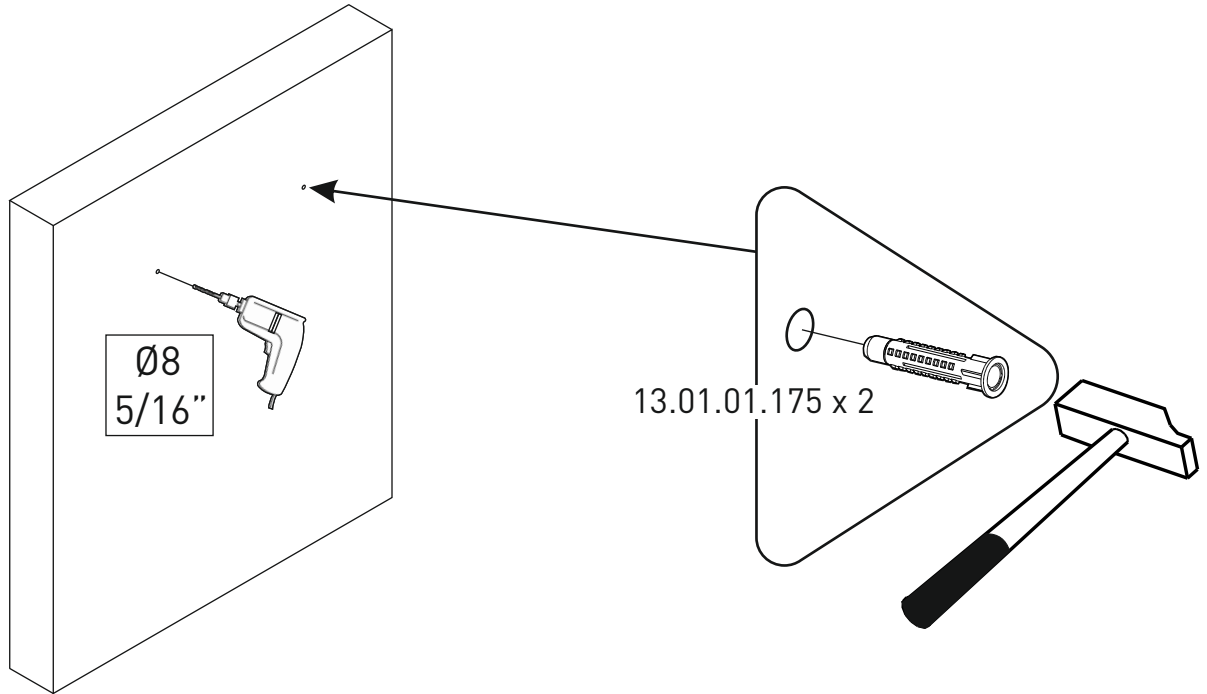

5

